

ALGIZ 10X

QUICK START GUIDE



handheld

WHAT'S IN THE BOX

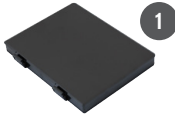

Ref.	Item	Description
1	Battery Pack	One 2 Cell Li-Ion Battery Pack
2	19V Adapter	19V Adapter w/ standard power cord
3	Hand Strap	

STARTING ALGIZ 10X

NOTE: You will be asked to enter your Microsoft Windows license number that is located under the main battery.

Press and hold power button for 4 seconds to power on the unit. Follow the on-screen instructions to get started with Windows. The screen calibration may not be accurate the first time you start the computer. Follow the procedure to calibrate the touchscreen.

INSERT BATTERY PACK

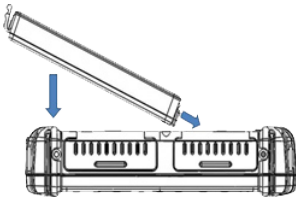

SCREEN CALIBRATION

1. Open Control Panel > Hardware and Sound > Tablet PC Settings
2. Click Calibrate and follow instructions

Repeat step 1 and 2 until you are satisfied with the calibration.





FUNCTION KEYS



Ref.	Components	Description
1	Power button*	Hold down for 4 seconds to turn the computer on
2	Touch mode/lock	Touch mode selection. Lock screen.
3	Menu	Controls brightness, volume, battery, power to modules and system information.
4	Windows key	Open start menu
5	Function keys	Two programmable buttons. Press menu to configure.

* If computer does not respond you can power off by holding down the Power Button until the LEDs switches off. Hold down for about 10 seconds.

LED INDICATORS

Ref.	Symbol	Indicator Status Description
Power mode		Green: System is on No light: System is off or LED indicators are off in HotTab
Storage Status		Flashing green light: SSD is reading/writing data
Radio Status		Green: Indicates that any transmitting radio is turned on (WiFi, BT, WWAN)
Battery Status		Green: Full battery, Red: Low battery, Orange: Charging Flashing red: Running on Hot-swap battery
GPS Status		Green: Indicates GPS power on

REAR SIDE

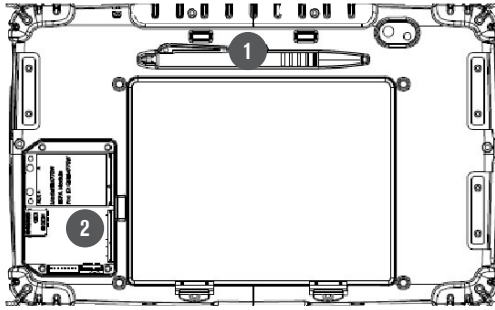

Ref.	Item	Description
1	Stylus Pen	-
2	Service Window	Expansion slots

LEFT AND RIGHT SIDE



Ref.	Item	Description
1	DC Power Jack	-
2	VGA	For connecting external display devices such as monitors and projectors
3	USB 2.0 Port	-
4	RS232	Accepts external connections using the interface of RS232 (D-sub 9 pins)
5	Micro SD Card Slot	Accepts Micro SDXC (up to 2TB)
6	SIM Card Slot	-
7	Combo Audio Jack	Audio in and out
8	USB 3.0 Port	-
9	Ethernet (RJ45)	10/100/1000-based network

Please go to www.handheldgroup.com/knowledgebase to download more information.

Algiz 10X is in compliance with the essential requirements and other relevant provisions of Directive 1999/5/EC. The declaration of conformity may be consulted at www.handheldgroup.com/algiz-10x/#tab=manuals

Version 3.0

handheld
www.handheldgroup.com